

Isıtma, Soğutma, İklimlendirme, Endüstri

Monoblok Pompalar

Wilo-Bloc-BM

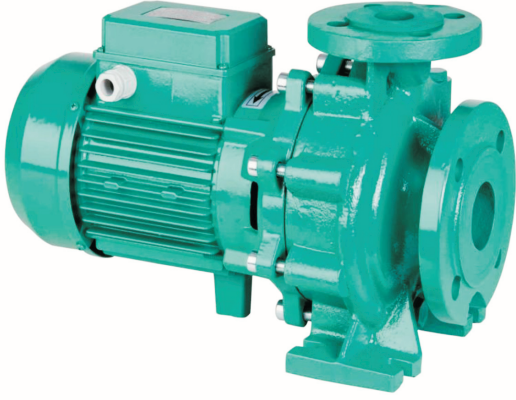

Dizayn

Kuru rotorlu(salmastralı), monoblok tip pompa, kaplinli

Uygulama

Isıtma, Soğutma ve iklimlendirme uygulamalarında sıcak ve soğuk su, su-glikol karışımları (glikol oranı %20-40 ve akışkan sıcaklığı $\leq 40^{\circ}\text{C}$) transferi

Basınçlandırma

Endüstriyel uygulamalar

Pompa Kodlaması

Örnek : **BM 50/130-3/2**

BM Blok pompa, dökme demir
BM-S : paslanmaz çelik
BM-B : bronz

50 Basma flanşı nominal çapı DN

130 Nominal çark çapı

3 Nominal motor gücü P_2 , kW

2 Kutup sayısı

Ürün Özellikleri / Faydalar

- EN733'e uygun standart pompa ölçüleri
- Bronz ve paslanmaz çelik gövde-çark opsiyonu ile korozif ve agresif akışkanlara uygunluk
- Kompakt ve hafif tasarım ile montaj ve bakım kolaylığı
- Tüm modellerde pompa gövdesi ve motordaki özel ayaklar ile montaj kolaylığı

Wilo-Bloc-BM Teknik Özellikler

Wilo-BM	
İzin Verilen Akışkanlar (diğer akışkanlar için danışınız)	
VDI 2035'e uygun ısıtma suyu	•
Su-glikol karışımları (glikol oranı %20-40 ve akışkan sıcaklığı ≤ 40°C)	•
Soğuk su	•
Çalışma Değerleri	
Standart Versiyon için maksimum çalışma basıncı [bar]	10
Sıcaklık Aralığı [°C]	-10 - +90
Maksimum ortam sıcaklığı [°C]	40
Bağlantılar	
Nominal bağlantı çapı DN	32-125
Flanşlar (EN 1902-2)	PN10
Malzemeler	
Pompa gövdesi	EN-GJL-250 BM-S versiyon : 1.4408, BM-B versiyon : G-CuSn 10
Çark	EN-GJL250 BM-S versiyon : 1.4408, BM-B versiyon : G-CuSn 10
Pompa mili	1.4057 (1.4401 / 1.4362 / 1.4462 özel versiyon)
Mekanik salmastra	BVEGG (BM-S ve BM-B için Q1Q1VGG)
Diğer mekanik salmastralar	Özel versiyon
Elektrik bağlantıları	
Voltaj	3~ 400 V, 50 Hz
Hız [d/d]	1450-2900
Motor	
Koruma sınıfı	IP55
Yalıtım sınıfı	F
Motor sargıları ≤3 kW	230 V Δ / 400 V Y, 50 Hz
Motor sargıları ≥ 4 kW	400 V Δ / 690 V Y, 50 Hz

Wilo-Bloc-BM Karakteristik Eğriler

Wilo-Bloc-BM100/220-5,5/4 - BM100/185-7,5/4

Devir hızı 1450 d/d

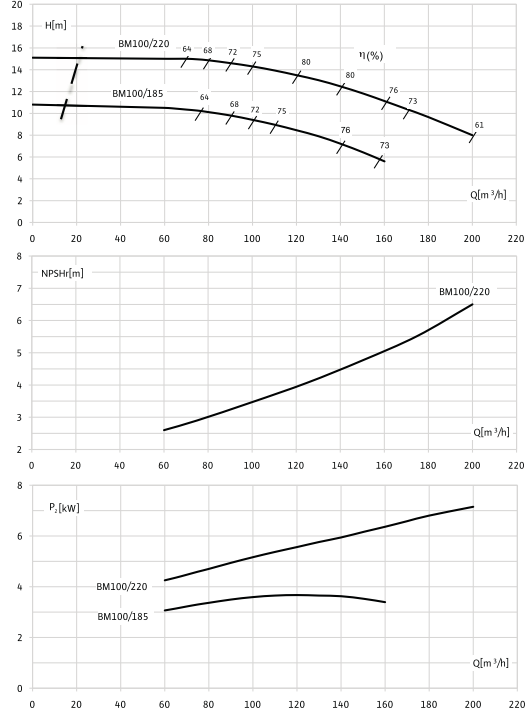

Wilo-Bloc-BM100/270-15/4 - BM100/250-9/4

Devir hızı 1450 d/d

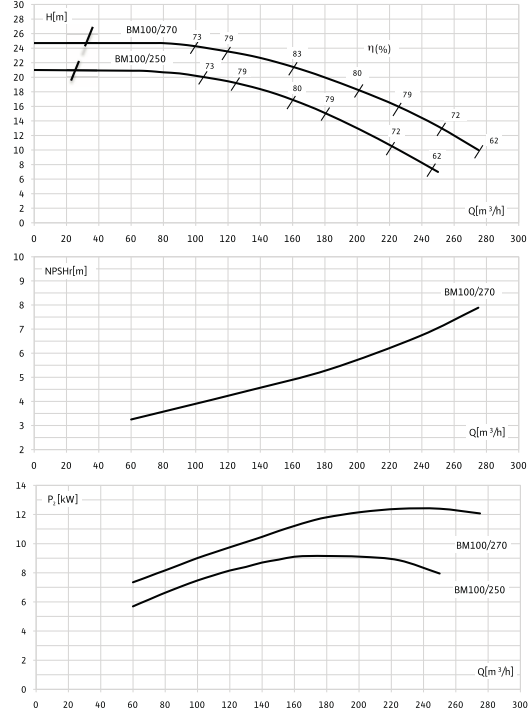

Wilo-Bloc-BM100/315-30/4 - BM100/295-18,5/4

Devir hızı 1450 d/d

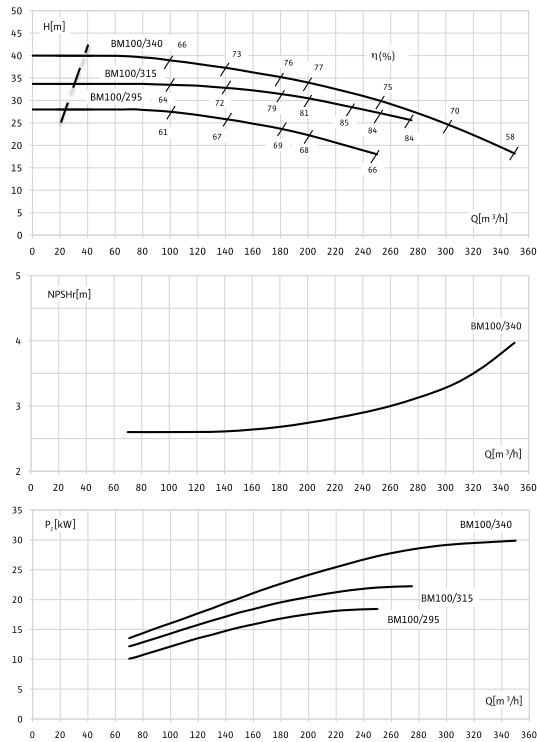

Wilo-Bloc-BM125/270-18,5/4 - BM125/235-11/4

Devir hızı 1450 d/d

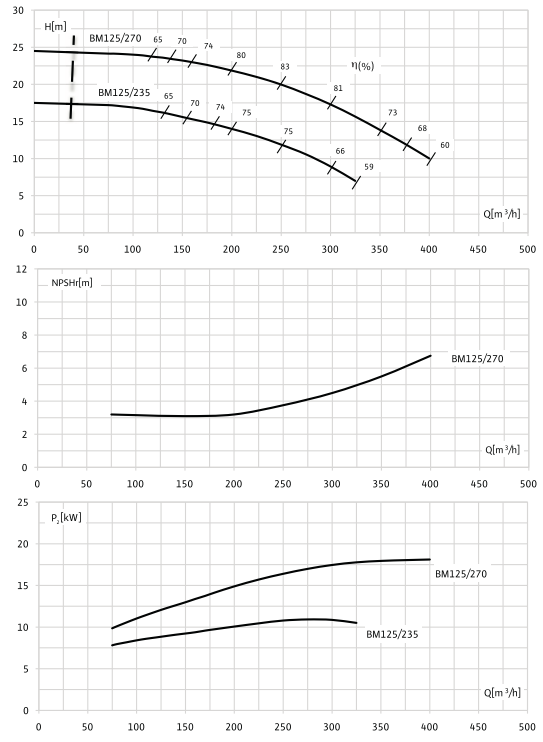

Wilo-Bloc-BM Karakteristik Eğriler

Wilo-Bloc-BM125/315-30/4 – BM125/295-18,5/4

Devir hızı 1450 d/d

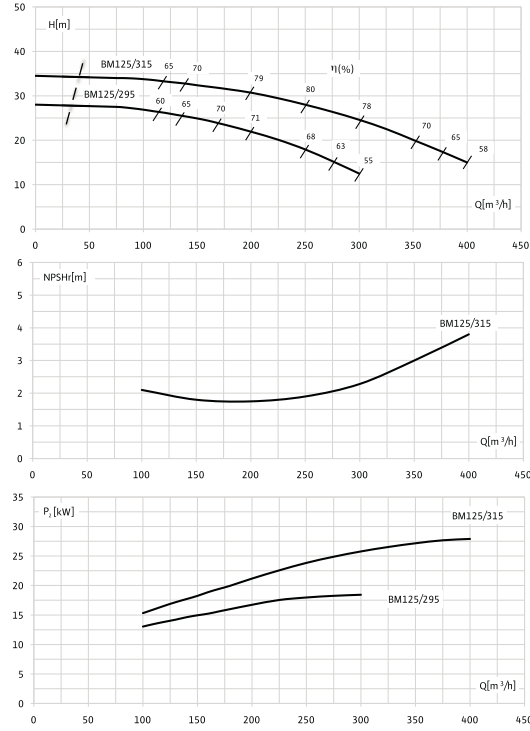

Wilo-Bloc-BM32/140-0,37/4

Devir hızı 1450 d/d

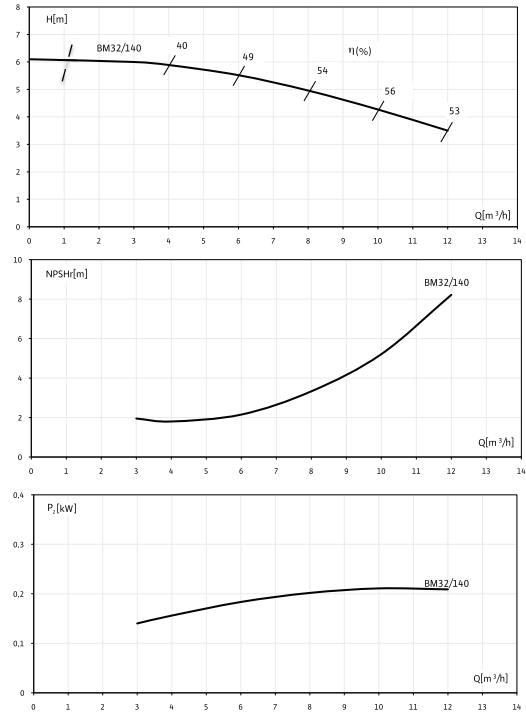

Wilo-Bloc-BM32/170-0,55/4

Devir hızı 1450 d/d

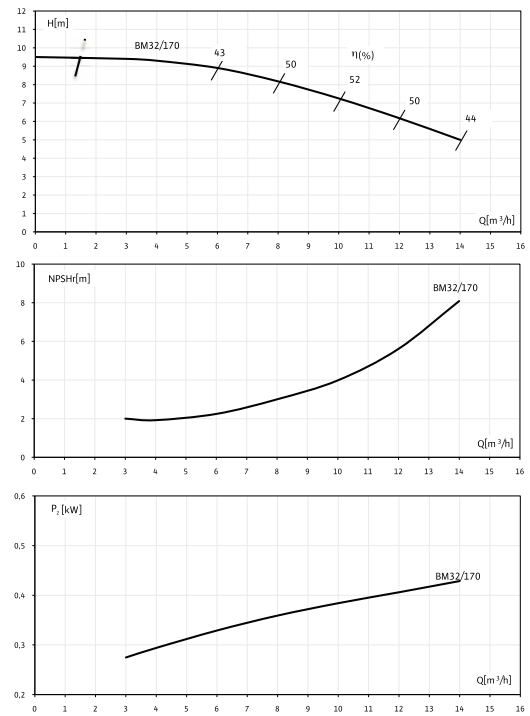

Wilo-Bloc-BM32/220-1,1/4

Devir hızı 1450 d/d

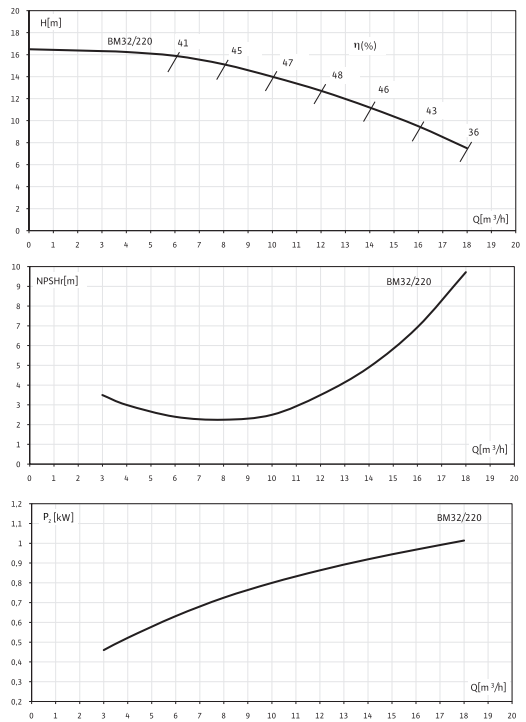

Wilo-Bloc-BM Karakteristik Eğriler

Wilo-Bloc-BM32/260-2,2/4 - BM32/240-2,2/4

Devir hızı 1450 d/d

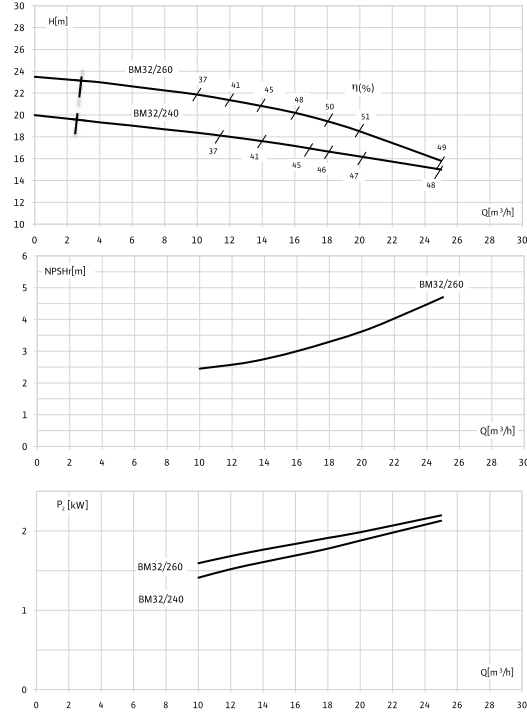

Wilo-Bloc-BM40/145-0,37/4

Devir hızı 1450 d/d

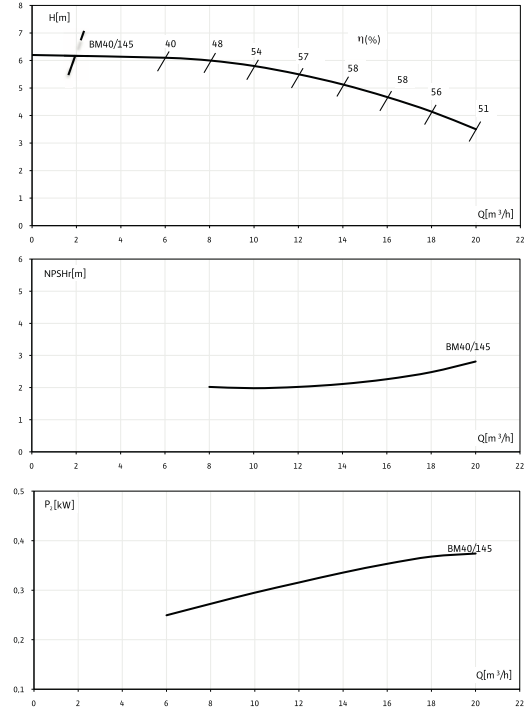

Wilo-Bloc-BM40/170-0,75/4

Devir hızı 1450 d/d

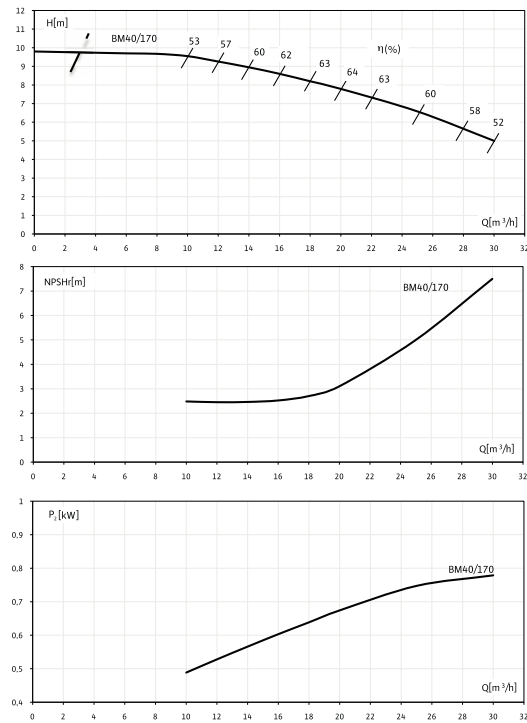

Wilo-Bloc-BM40/210-1,1/4

Devir hızı 1450 d/d

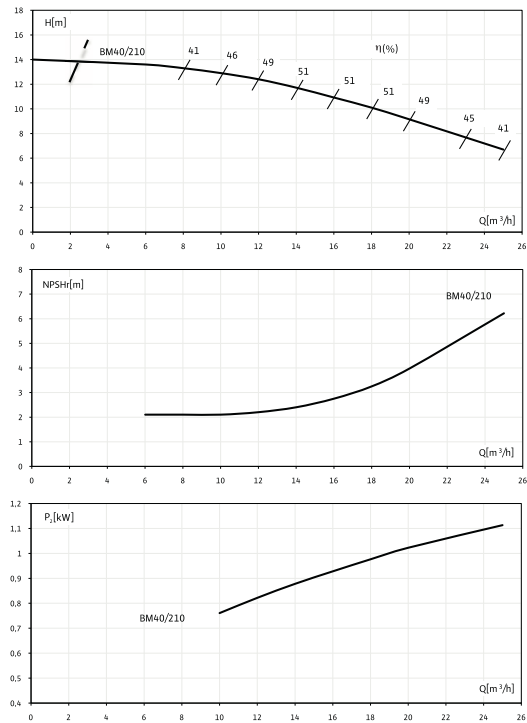

Wilo-Bloc-BM Karakteristik Eğriler

Wilo-Bloc-BM40/260-3/4 - BM40/240-2,2/4

Devir hızı 1450 d/d

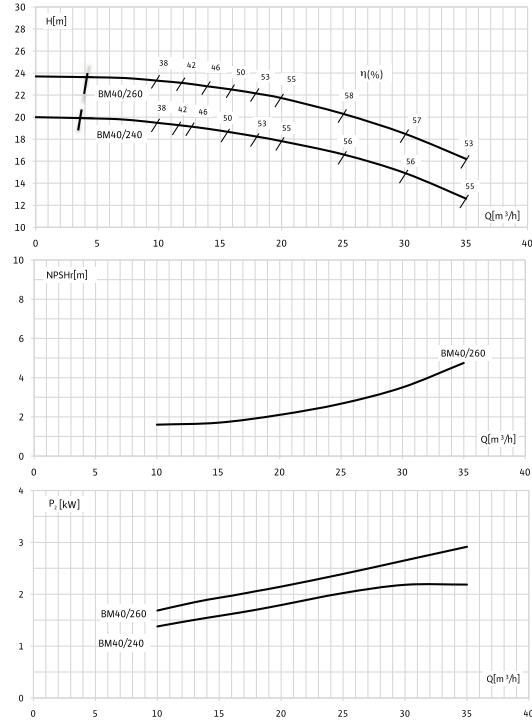

Wilo-Bloc-BM40/335-9/4 - BM40/275-4/4

Devir hızı 1450 d/d

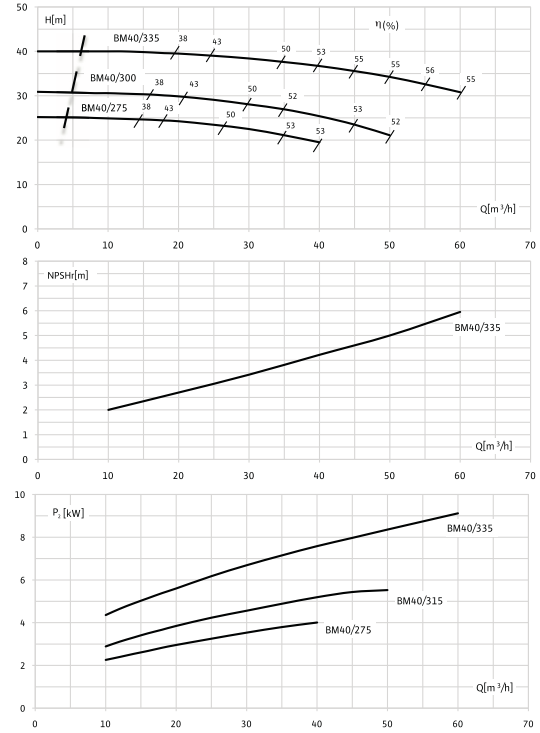

Wilo-Bloc-BM50/140-0,55/4

Devir hızı 1450 d/d

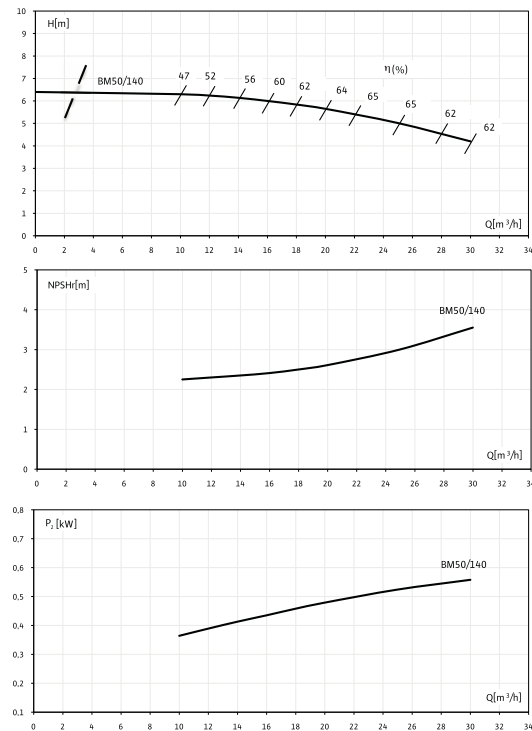

Wilo-Bloc-BM50/175-1,1/4

Devir hızı 1450 d/d

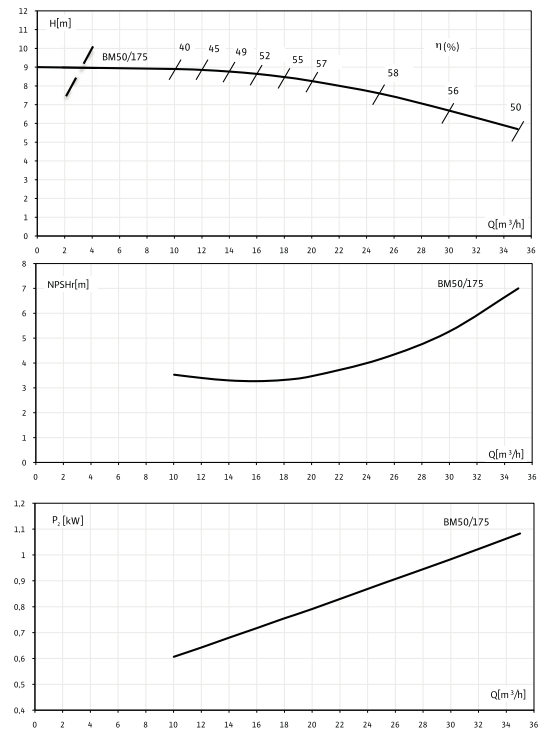

Isıtma, Soğutma, İklimlendirme, Endüstri

Monoblok Pompalar

Wilo-Bloc-BM Karakteristik Eğriler

Wilo-Bloc-BM50/210-1,5/4

Devir hızı 1450 d/d

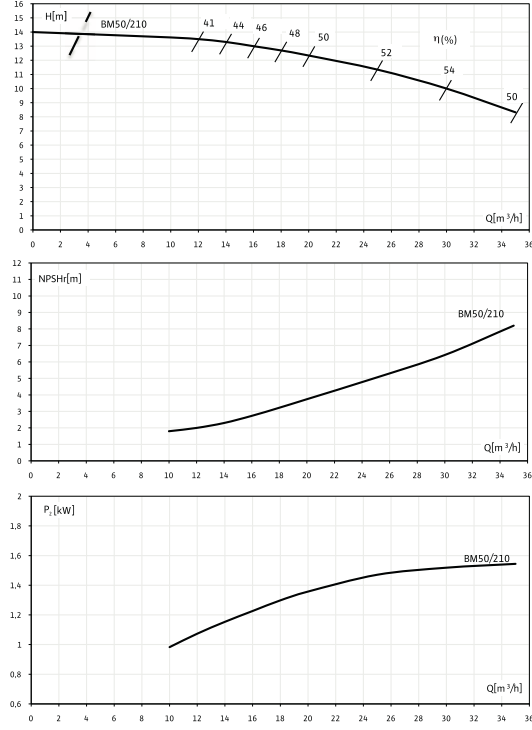

Wilo-Bloc-BM50/220-2,2/4

Devir hızı 1450 d/d

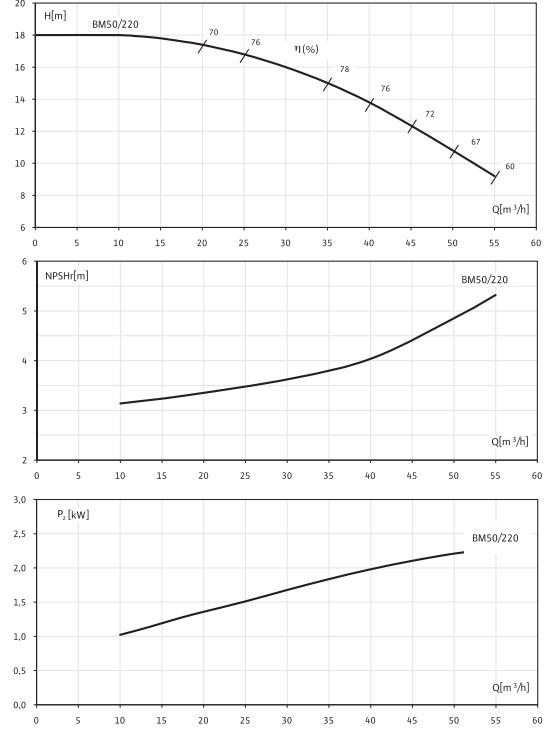

Wilo-Bloc-BM50/260-4/4 - BM50/220-2,2/4

Devir hızı 1450 d/d

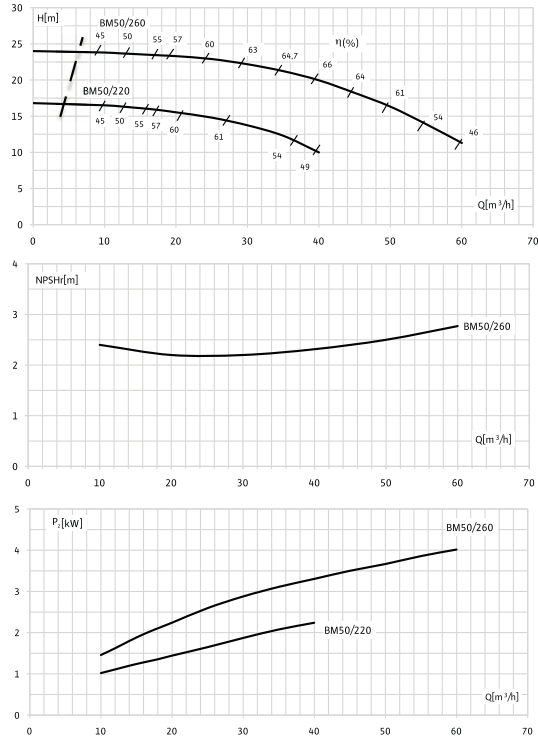

Wilo-Bloc-BM65/135-0,75/4

Devir hızı 1450 d/d

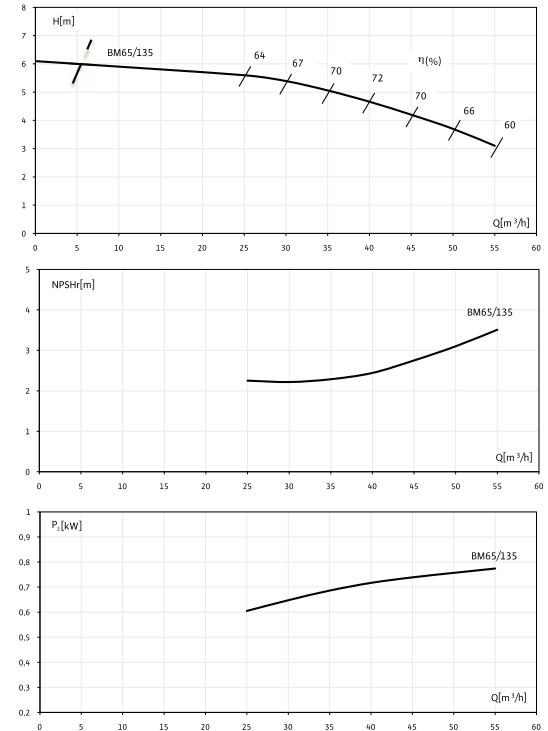

Wilo-Bloc-BM Karakteristik Eğriler

Wilo-Bloc-BM65/170-1,5/4

Devir hızı 1450 d/d

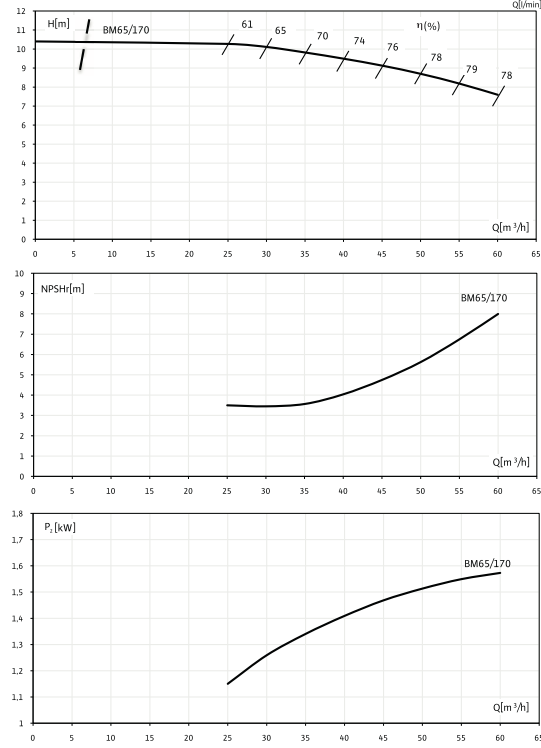

Wilo-Bloc-BM65/200-3/4

Devir hızı 1450 d/d

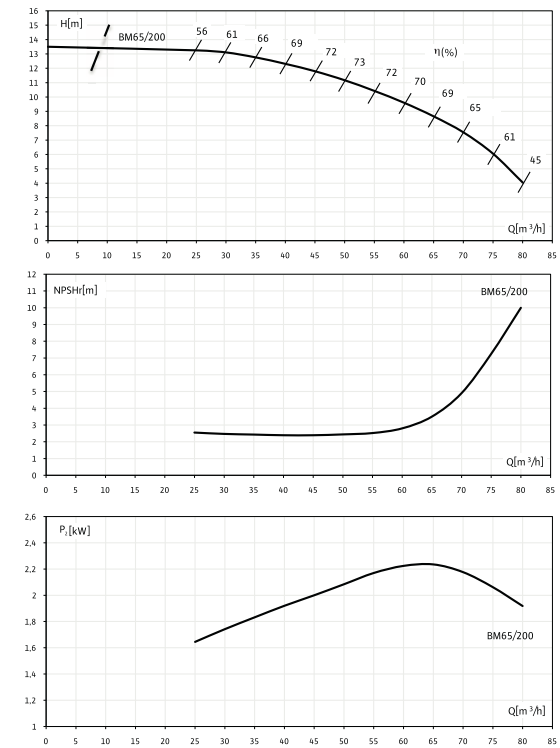

Wilo-Bloc-BM65/215-3/4

Devir hızı 1450 d/d

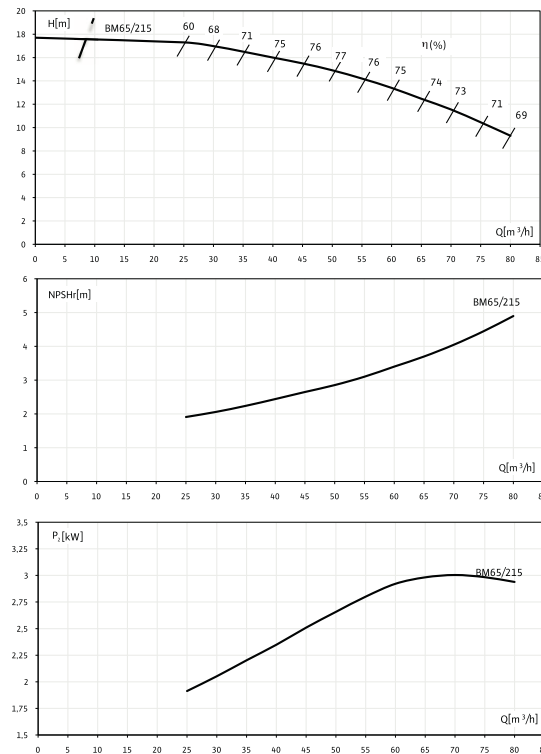

Wilo-Bloc-BM65/250-5,5/4 - BM65/235-4/4

Devir hızı 1450 d/d

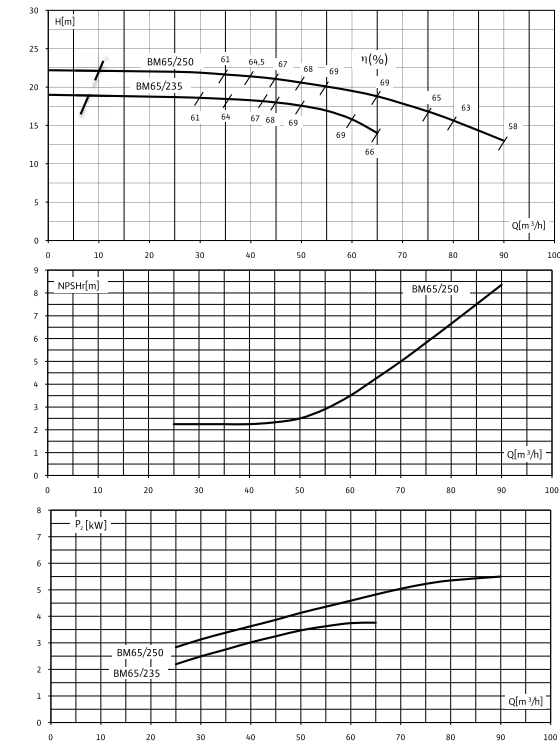

Wilo-Bloc-BM Karakteristik Eğriler

Wilo-Bloc-BM65/340 - BM65/290

Devir hızı 1450 d/d

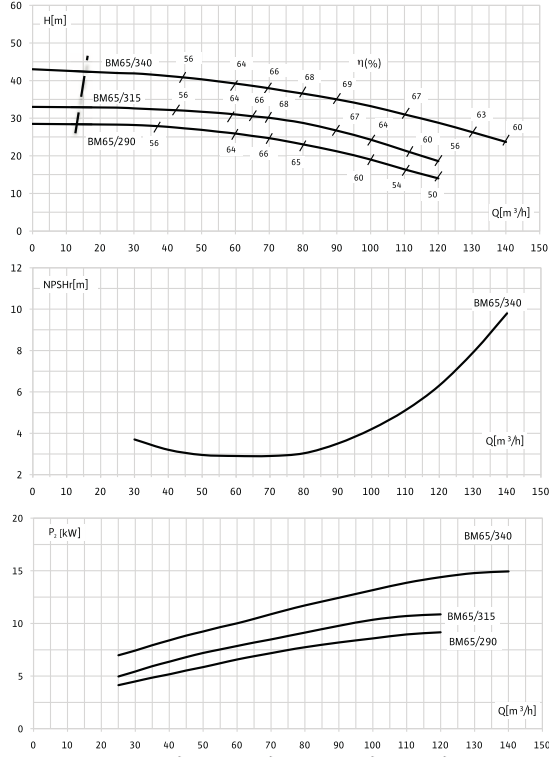

Wilo-Bloc-BM80/175-2,2/4 - BM80/160-2,2/4

Devir hızı 1450 d/d

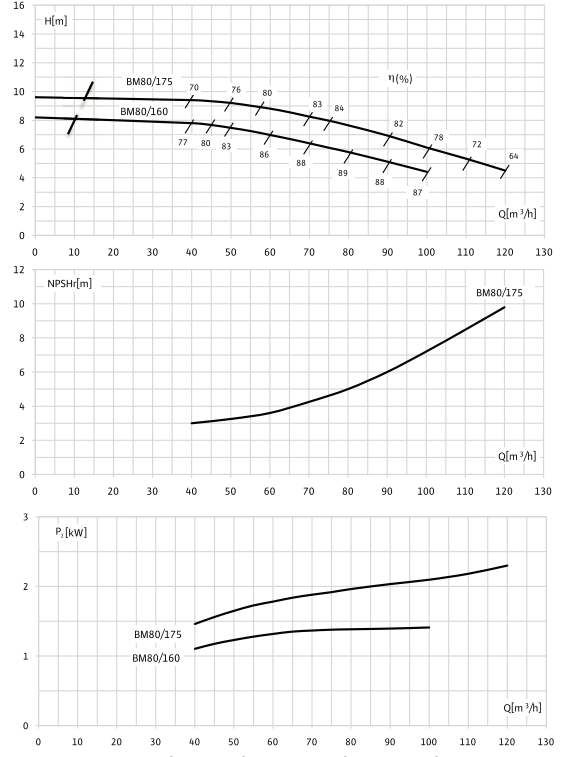

Wilo-Bloc-BM80/210-5,5/4 - BM80/195-4/4

Devir hızı 1450 d/d

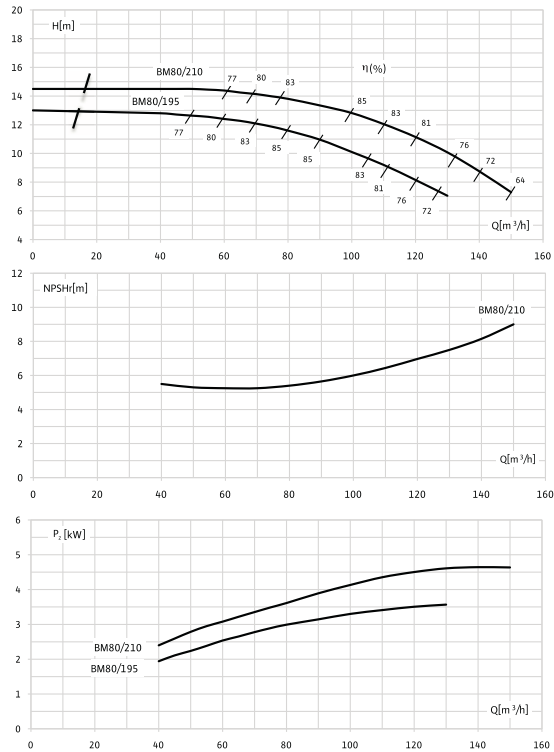

Wilo-Bloc-BM80/270-9/4 - BM80/230-7,5/4

Devir hızı 1450 d/d

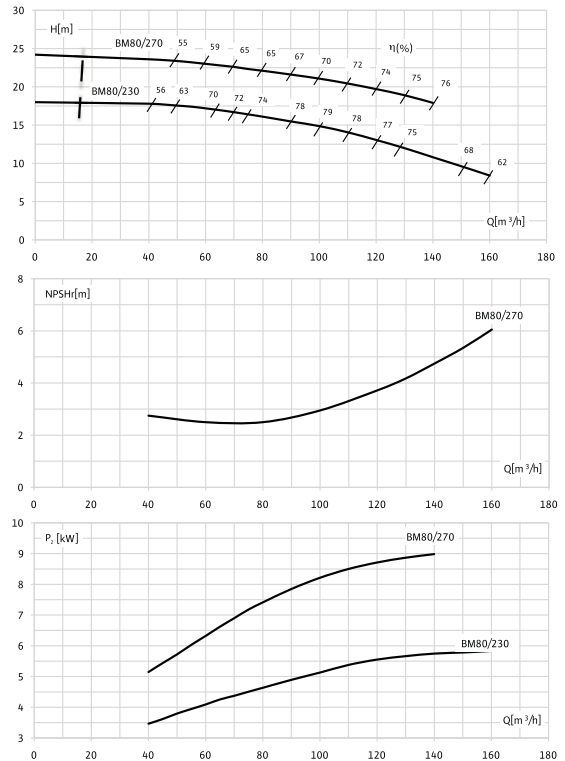

Wilo-Bloc-BM Karakteristik Eğriler

Wilo-Bloc-BM80/340-22/4 - BM80/290-11/4

Devir hızı 1450 d/d

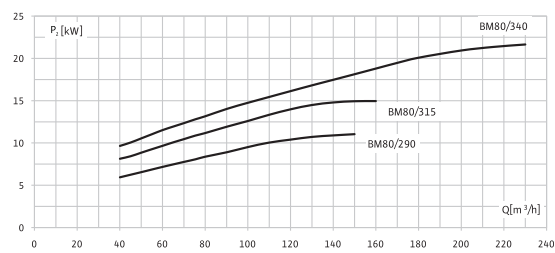
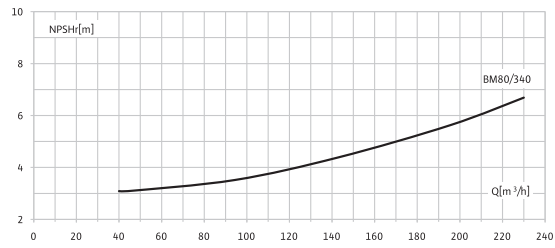
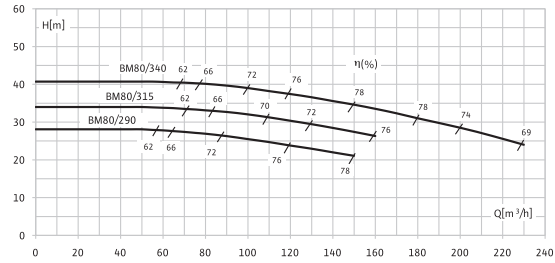

Wilo-Bloc-BM Karakteristik Eğriler

Wilo-Bloc-BM 32/140-1,5/2 - BM 32/125-0,75/2

Devir hızı 2900 d/d

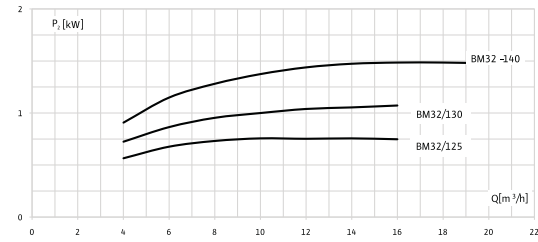
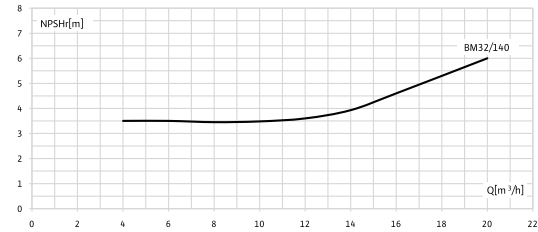
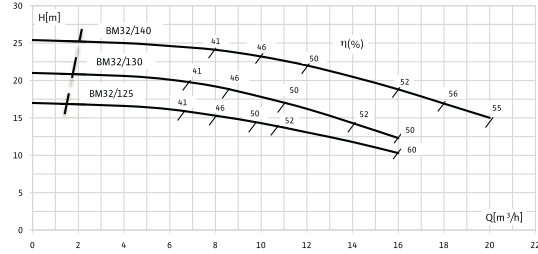

Wilo-Bloc-BM32/170-3/2 - BM 32/150-1,5/2

Devir hızı 2900 d/d

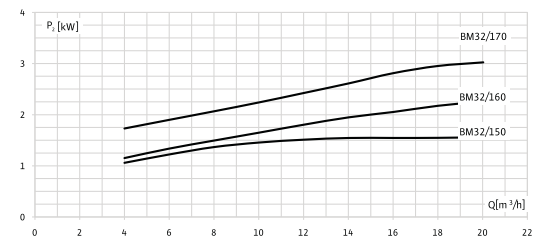
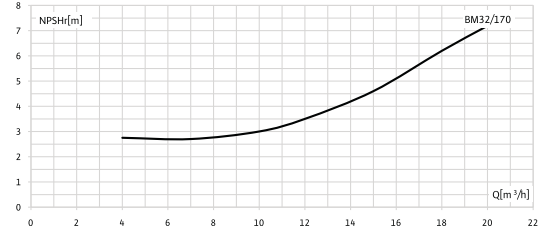
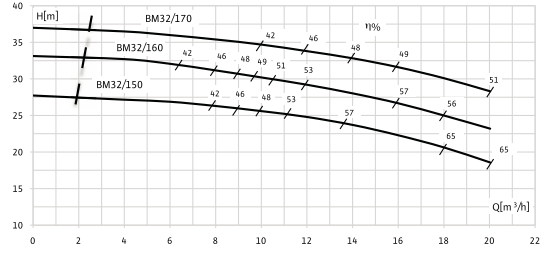

Wilo-Bloc-BM32/175-5,5/2 - BM32/155-3/2

Devir hızı 2900 d/d

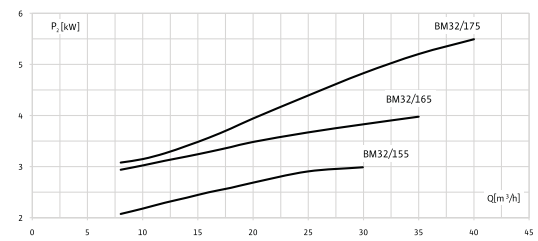
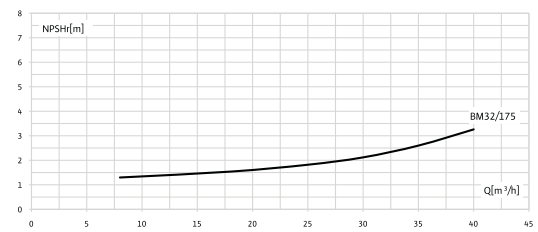
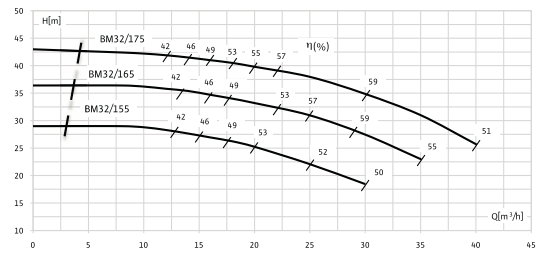

Wilo-Bloc-BM32/215-7,5/2 - BM32/190-4/2

Devir hızı 2900 d/d

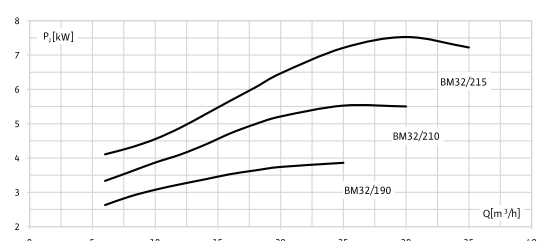
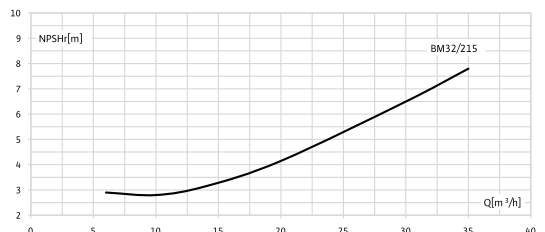
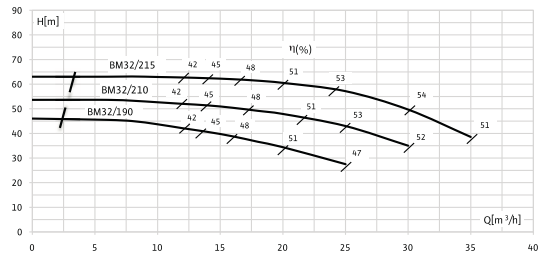

Wilo-Bloc-BM Karakteristik Eğriler

Wilo-Bloc-BM32/260-15/2 - BM32/220-7,5/2

Devir hızı 2900 d/d

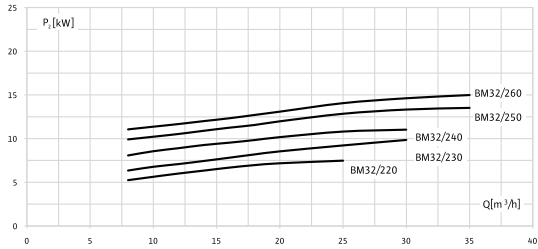
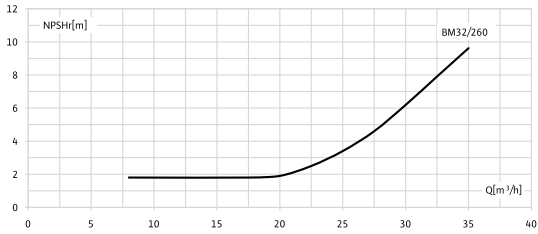
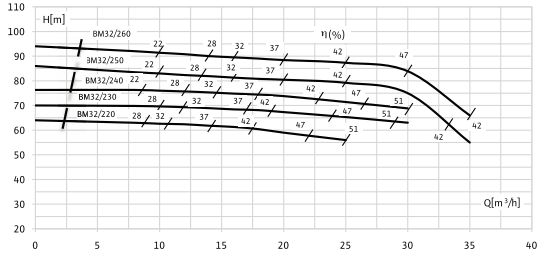

Wilo-Bloc-BM40/145-3/2 - BM40/125-1,5/2

Devir hızı 2900 d/d

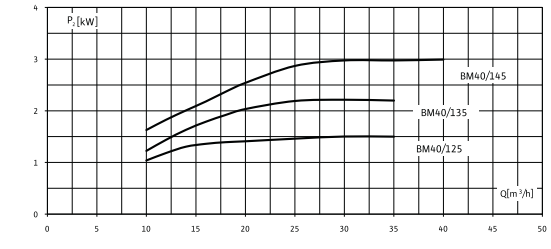
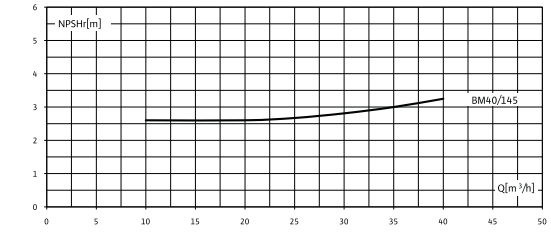
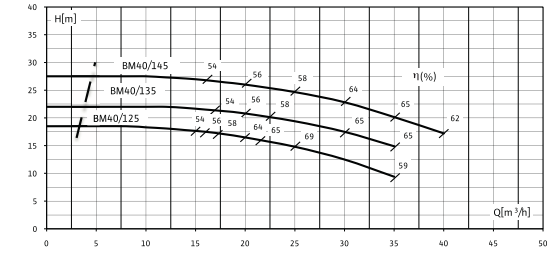

Wilo-Bloc-BM 40/170-5,5/2 - BM 40/155-3/2

Devir hızı 2900 d/d

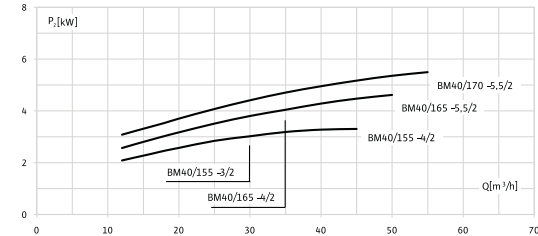
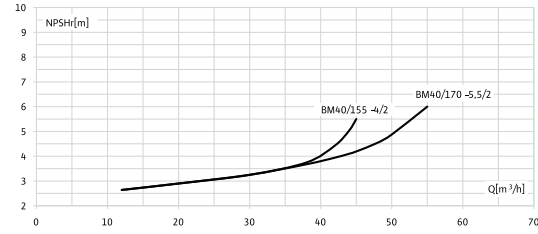
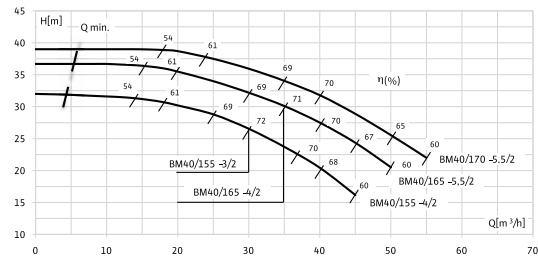

Wilo-Bloc-BM40/210-7,5/2 - BM40/185-4/2

Devir hızı 2900 d/d

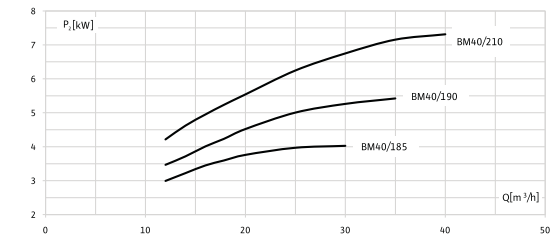
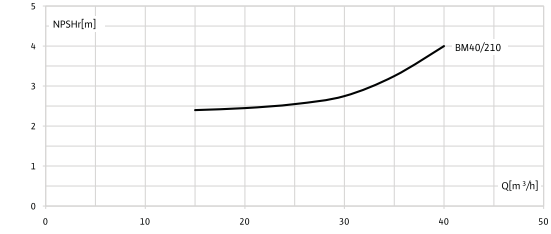
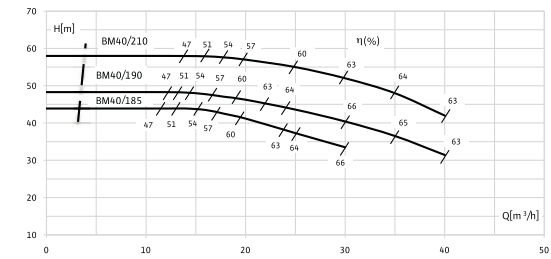

Wilo-Bloc-BM Karakteristik Eğriler

Wilo-Bloc-BM40/215-11/2 - BM40/195-7,5/2

Devir hızı 2900 d/d

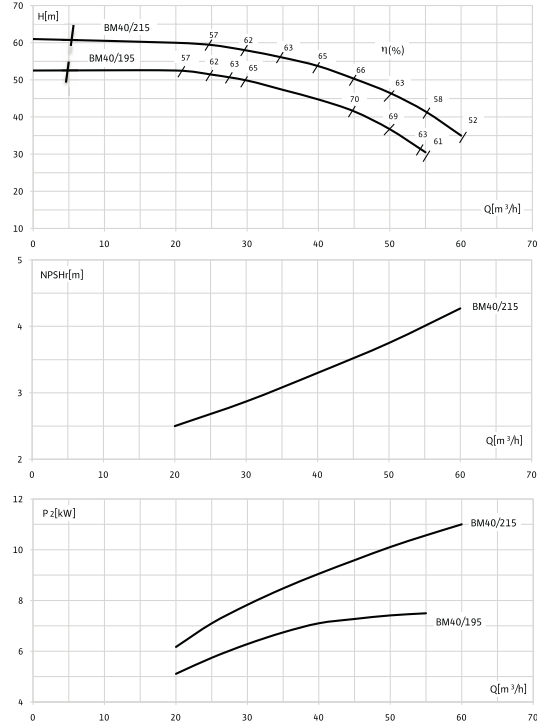

Wilo-Bloc-BM40/255-15/2 - BM40/220-9/2

Devir hızı 2900 d/d

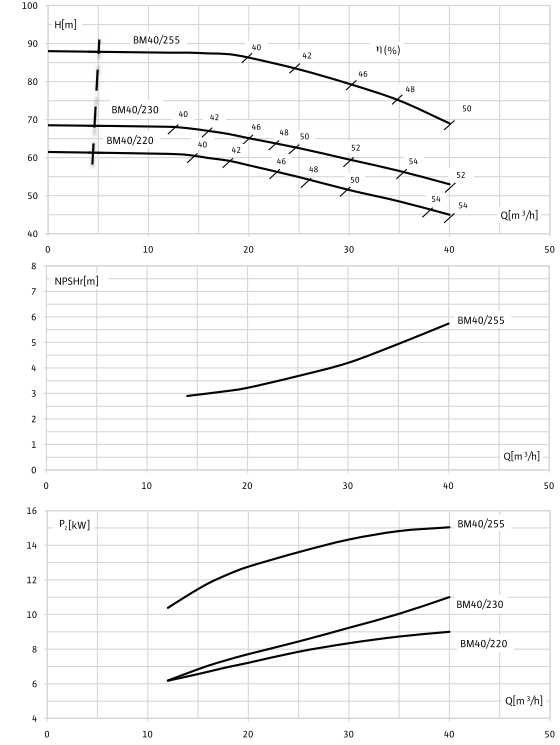

Wilo-Bloc-BM40/260-22/2 - BM40/225-12,5/2

Devir hızı 2900 d/d

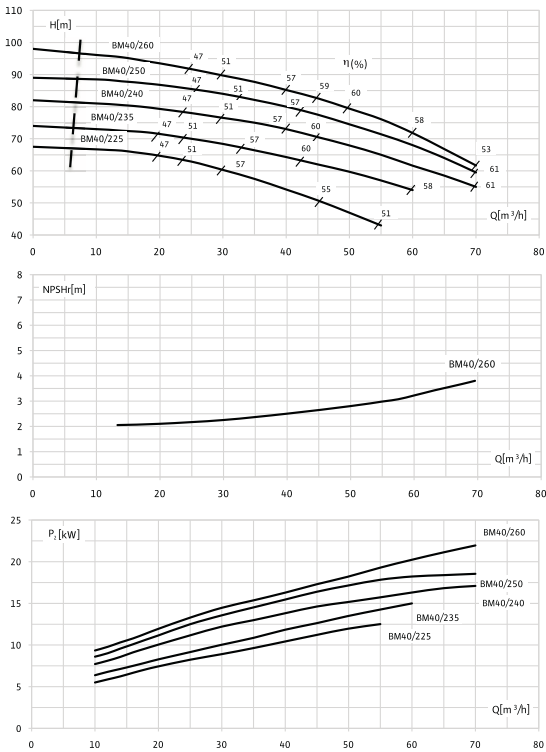

Wilo-Bloc-BM50/140 - BM50/120

Devir hızı 2900 d/d

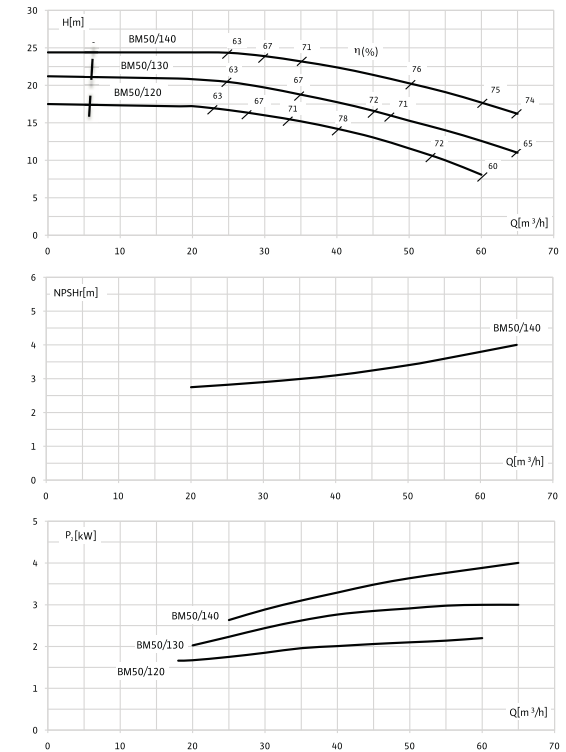

Wilo-Bloc-BM Karakteristik Eğriler

Wilo-Bloc-BM50/170-7,5/2 - BM50/160-5,5/2

Devir hızı 2900 d/d

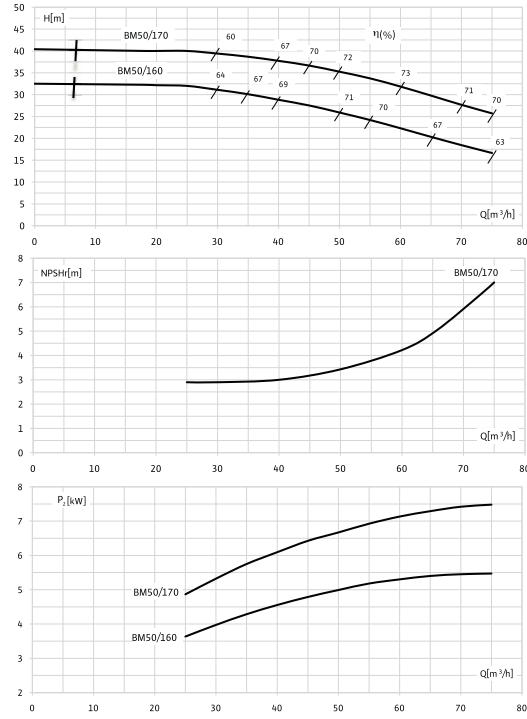

Wilo-Bloc-BM50/175-9/2 - BM50/150-5,5/2

Devir hızı 2900 d/d

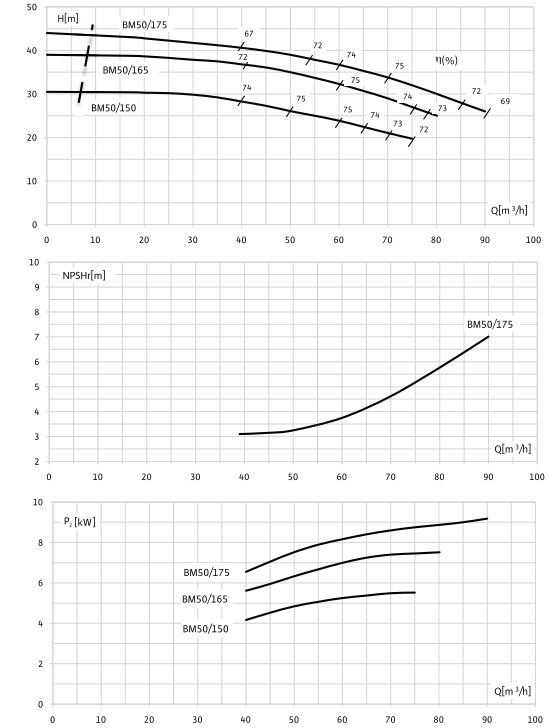

Wilo-Bloc-BM50/215-12,5/2 - BM50/195-9/2

Devir hızı 2900 d/d

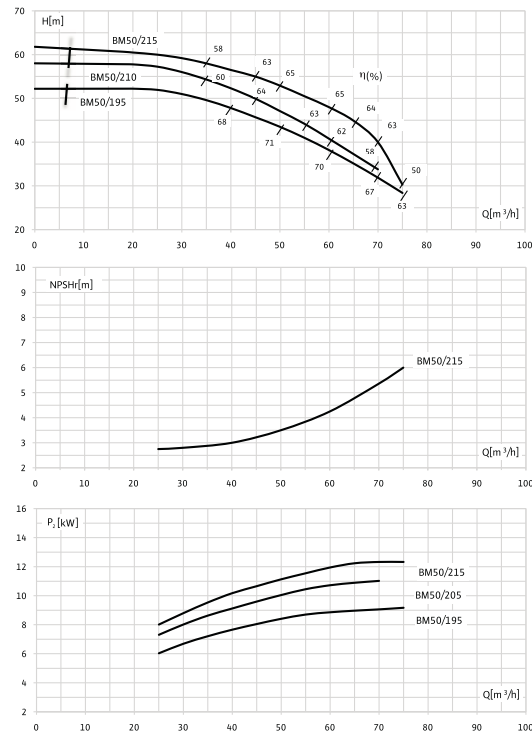

Wilo-Bloc-BM50/220-22/2 - BM50/195-15/2

Devir hızı 2900 d/d

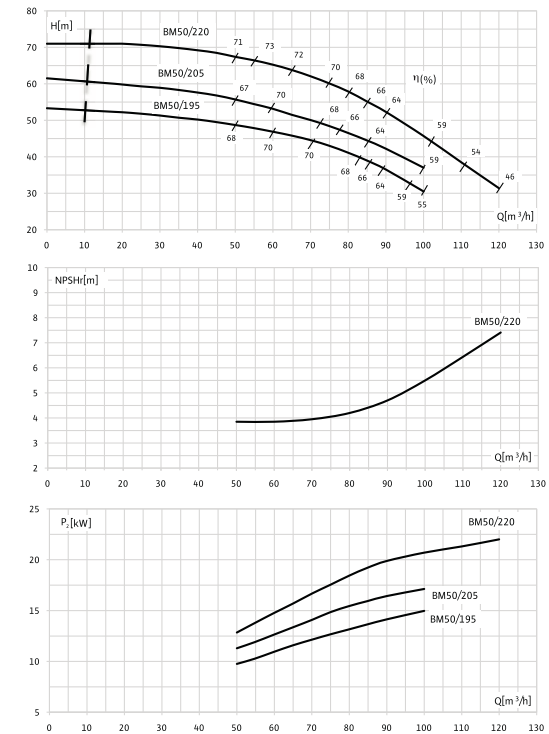

Wilo-Bloc-BM Karakteristik Eğriler

Wilo-Bloc-BM50/260-30/2 - BM50/225-17/2

Devir hızı 2900 d/d

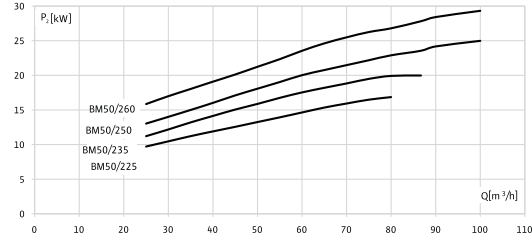
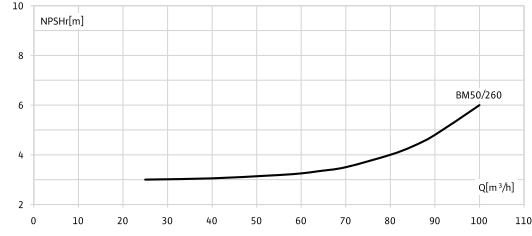
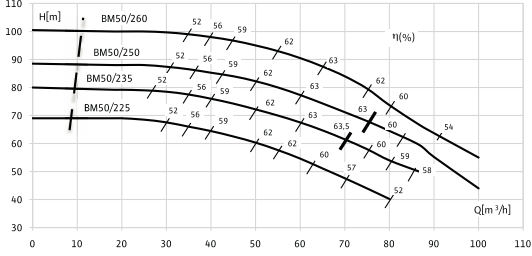

Wilo-Bloc-BM65/145-7,5/2 - BM65/115-3/2

Devir hızı 2900 d/d

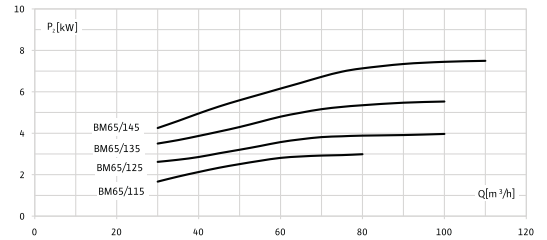
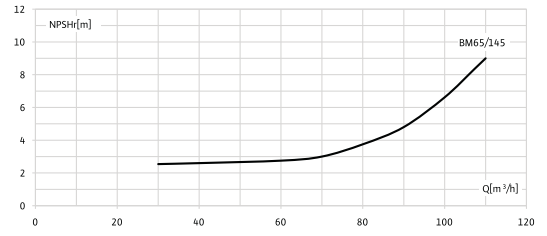
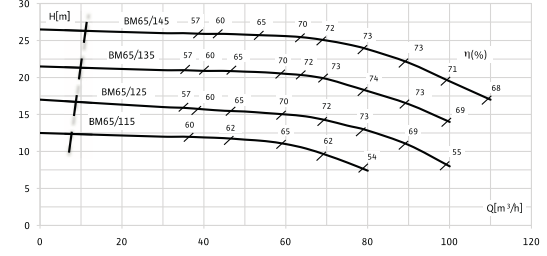

Wilo-Bloc-BM65/170-15/2 - BM65/150-9/2

Devir hızı 2900 d/d

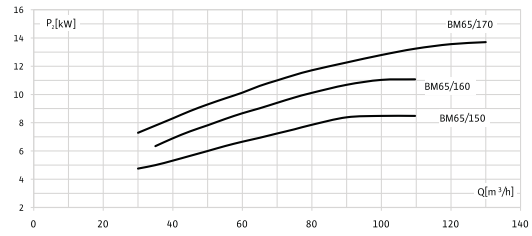
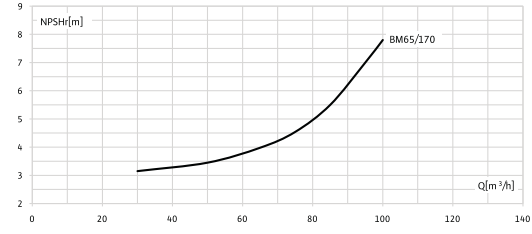
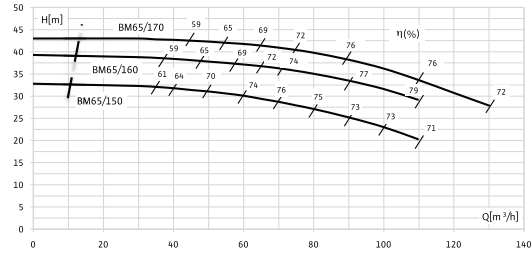

Wilo-Bloc-BM65/200-22/2 - BM65/180-15/2

Devir hızı 2900 d/d

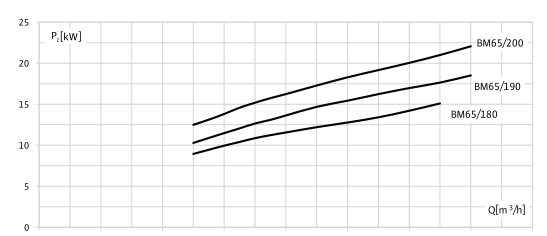
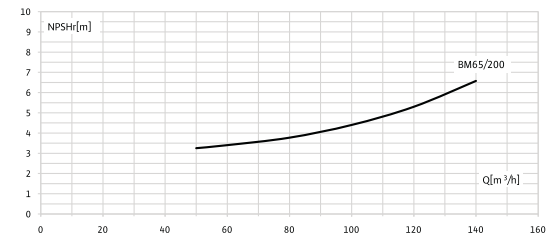
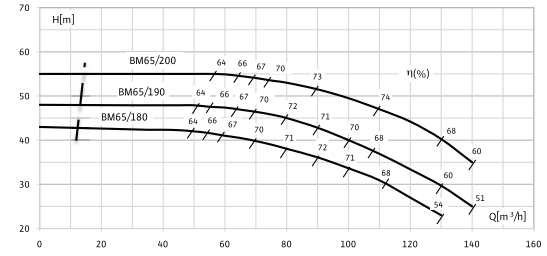

Wilo-Bloc-BM Karakteristik Eğriler

Wilo-Bloc-BM65/215-30/2 - BM65/185-18,5/2

Devir hızı 2900 d/d

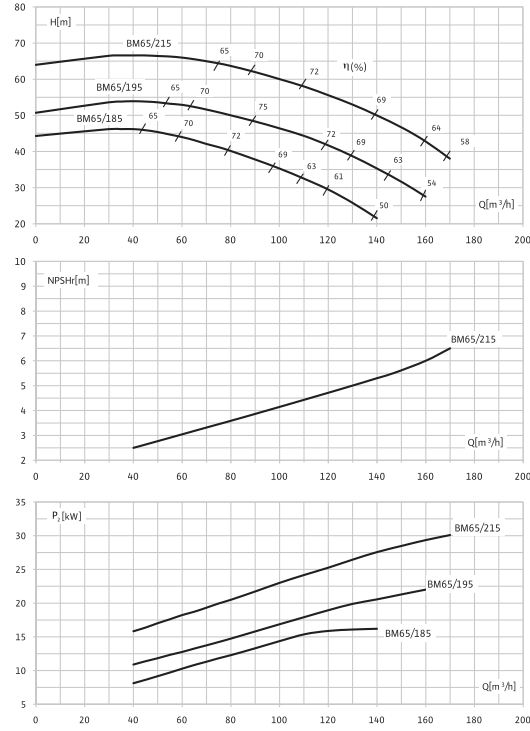

Wilo-Bloc-BM65/260-37/2 - BM65/220-22/2

Devir hızı 2900 d/d

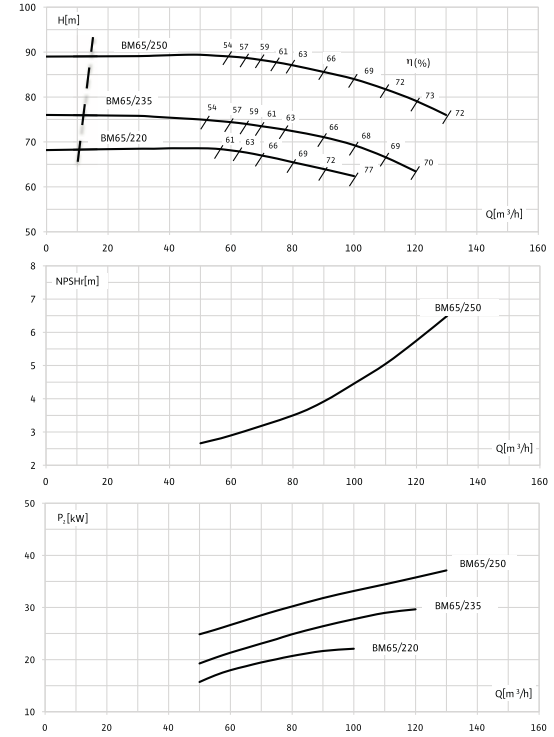

Wilo-Bloc-BM80/180-22/2 - BM80/130-5,5/2

Devir hızı 2900 d/d

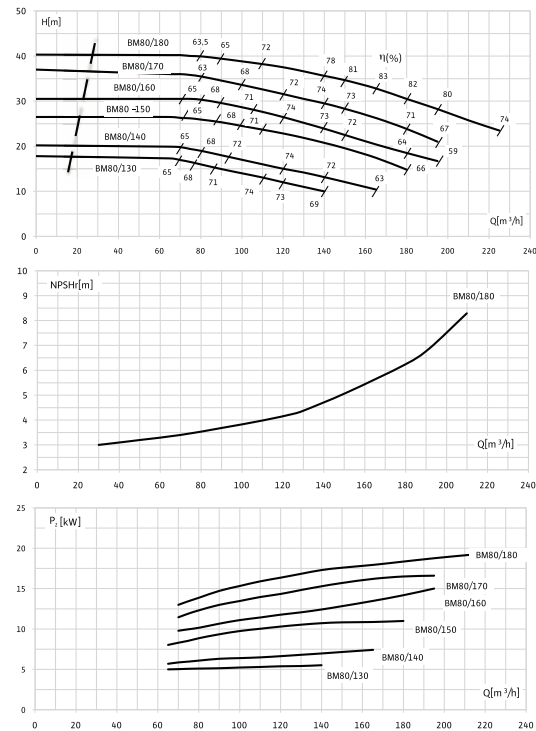

Wilo-Bloc-BM80/210-37/2 - BM80/200-30/2

Devir hızı 2900 d/d

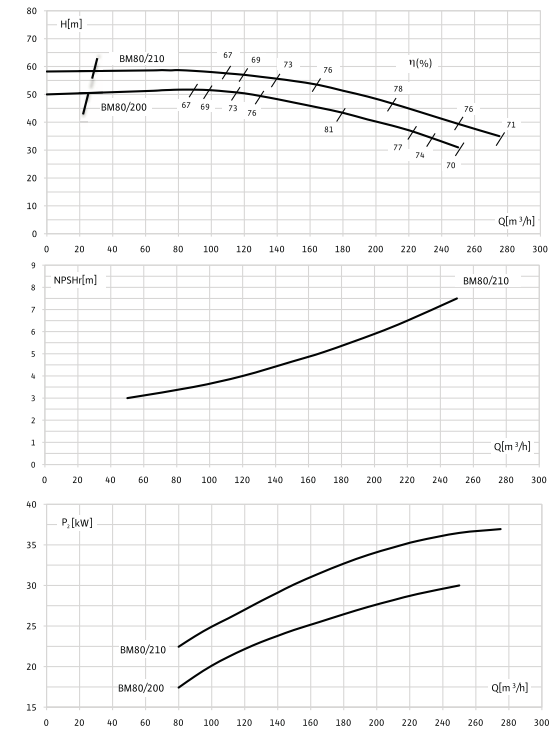

Isıtma, Soğutma, İklimlendirme, Endüstri

Monoblok Pompalar

Wilo-Bloc-BM Bağlantı Şemaları, Motor Bilgileri

Bağlantı şeması

Y resim

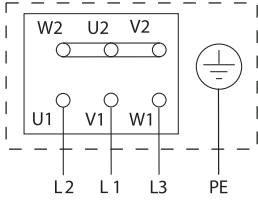

Δ resim

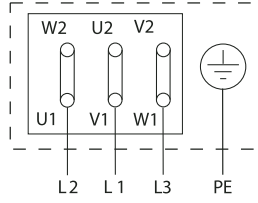

Motor koruma svici kullanılmalıdır. Dönüş yönü kontrol edilmelidir. Dönüş yönünü değiştirmek için, herhangi iki fazı yer değiştirin

$P2 \leq 3 \text{ kW}$ 3~400V Y
3~230V Δ
 $P2 \geq 4 \text{ kW}$ 3~690V Y
3~400V Δ

Köprüler kaldırılarak, Y- Δ kalkış mümkündür.

Motor Bilgileri (1450 d/d)

Wilo-Bloc-BM(-S/-B)	Nominal Akım I_N (yaklaşık)		Güç Faktörü Cos φ	Verim μM
	3~230/400V	3~400V Δ		
	[A]			
0.37 kW	1.7/1.0	1.0	0.73	74.5
0.55 kW	1.7/1.1	1.1	0.73	75.5
0.75 kW	2.8/1.6	1.6	0.74	76.0
1.1 kW	4.3/2.5	2.5	0.80	79.5
1.5 kW	6.6/4.0	4.0	0.81	81.0
2.2 kW	9.7/5.6	5.6	0.80	81.0
3 kW	10.4/6.0	6.0	0.80	84.0
4 kW	14.0/8.2	8.2	0.80	85.0
5.5 kW		10.0	0.86	84.0
7.5 kW		12.7	0.86	86.0
9.2 kW		19.8	0.86	86.0
11 kW		21.3	0.82	91.0
15 kW		27.7	0.83	92.0
18.5 kW		37.0	0.82	86.0
22 kW		46.0	0.82	87.0
30 kW		53.1	0.83	89.0

Wilo-Bloc-BM Bağlantı Şemaları, Motor Bilgileri

Motor Bilgileri (2900d/d)				
Wilo-Bloc-BM(-S/-B)	Nominal Akım I _N (yaklaşık)		Güç Faktörü	Verim
	3~230/400V	3~400V Δ	Cos φ	μM
	[A]			
0.75 kW	5.2/3.0		0.81	75.0
1.1 kW	6.9/4.0		0.81	77.0
1.5 kW	7.9/4.5		0.82	78.0
2.2 kW	8.4/4.8		0.82	85.0
3 kW	10.9/6.3		0.83	83.0
4 kW	14.4/8.5	8.5	0.84	85.5
5.5 kW		12.1	0.85	86.0
7.5 kW		14.2	0.86	87.0
9.2 kW		18.3	0.85	87.0
11 kW		22.3	0.86	87.5
12.5 kW		21.5	0.86	87.5
13.5 kW		26.4	0.86	87.7
15 kW		27.6	0.87	88.0
17.0 kW		31.0	0.87	88.5
18.5 kW		31.5	0.89	90.5
20.0 kW		37.8	0.89	91.0
22.0 kW		41.5	0.85	86.0
25.0 kW		45.0	0.86	87.0
30.0 kW		57.5	0.87	88.0
37.0 kW		73.0	0.88	89.5

Isıtma, Soğutma, İklimlendirme, Endüstri

Monoblok Pompalar

Wilo-Bloc-BM Ölçüler, Ağırlıklar

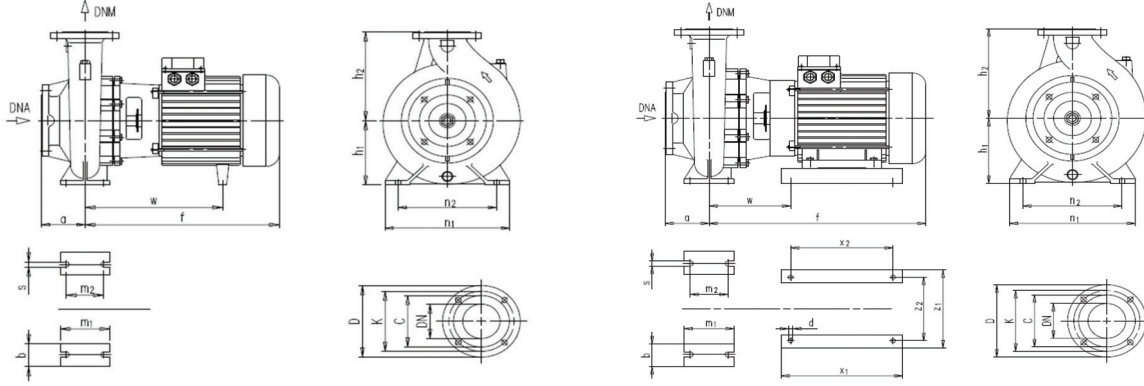

Ölçüler, Ağırlıklar (1450 d/d)

Wilo-Bloc-BM ...	Nominal Çap Ölçüler ve Ağırlıklar																
	f	a	m1	m2	n1	n2	h1	h2	s	b	w	x1	x2	z1	z2	d	Ağırlık [kg]
	[mm]																
BM 32/140-0,37/4	333	80	100	70	190	140	112	140	14	50	241	-	-	-	-	-	23
BM 32/170-0,55/4	333	80	100	70	240	190	132	160	14	50	241	-	-	-	-	-	29
BM 32/220-1,1/4	347	80	100	70	240	190	160	180	14	50	249	-	-	-	-	-	37
BM 32/240-2,2/4	395	100	125	95	320	250	180	25	14	65	275	-	-	-	-	-	48
BM 32/260-2,2/4	395	100	125	95	320	250	180	25	14	65	275	-	-	-	-	-	50
BM 40/145-0,37/4	333	80	100	70	210	160	112	140	14	50	241	-	-	-	-	-	24
BM 40/170-0,75/4	333	80	100	70	240	190	132	160	14	50	241	-	-	-	-	-	31
BM 40/210-1,1/4	347	100	100	70	265	212	160	180	14	50	249	-	-	-	-	-	38
BM 40/240-2,2/4	395	100	125	95	320	250	180	225	14	65	275	-	-	-	-	-	50
BM 40/260-3/4	395	100	125	95	320	250	180	225	14	65	275	-	-	-	-	-	54
BM 40/275-4/4	431	100	125	95	345	280	225	250	14	65	310	-	-	-	-	-	90
BM 40/300-5,5/4	452	100	125	95	345	280	225	250	14	65	329	-	-	-	-	-	105
BM 40/335-9/4	537	100	125	95	345	280	225	250	14	65	178	320	280	260	215	12	115
BM 50/140-0,55/4	333	100	100	70	240	190	132	160	14	50	241	-	-	-	-	-	29
BM 50/175-1,1/4	345	100	100	70	265	212	160	180	14	50	247	-	-	-	-	-	37
BM 50/210-1,5/4	376	100	100	70	265	212	160	200	14	50	278	-	-	-	-	-	42
BM 50/215-3/4	407	100	125	95	320	250	180	225	14	65	287	-	-	-	-	-	58
BM 50/220-2,2/4	395	100	125	95	320	250	180	225	14	65	275	-	-	-	-	-	54
BM 50/260-4/4	402	100	125	95	320	250	180	225	14	65	282	-	-	-	-	-	65
BM 65/135-0,75/4	333	100	125	95	280	212	160	180	14	65	241	-	-	-	-	-	32
BM 65/170-1,5/4	350	100	125	95	280	212	160	200	14	65	252	-	-	-	-	-	40
BM 65/200-3/4	400	100	125	95	280	250	180	225	14	65	280	-	-	-	-	-	56
BM 65/215-3/4	400	100	125	95	280	250	180	225	14	65	280	-	-	-	-	-	70
BM 65/235-4/4	429	100	160	120	360	280	200	250	18	80	306	-	-	-	-	-	74
BM 65/250-5,5/4	531	100	160	120	360	280	200	250	18	80	393	-	-	-	-	-	77
BM 65/290-9/4	543	125	160	120	400	315	225	280	18	80	164	320	280	260	215	12	173
BM 65/315-11/4	651	125	160	120	400	315	225	280	18	80	160	410	370	320	255	14	186
BM 65/340-15/4	651	125	160	120	400	315	225	280	18	80	160	410	370	320	255	14	204
BM 80/160-2,2/4	400	125	125	95	320	250	180	225	14	65	280	-	-	-	-	-	52
BM 80/175-2,2/4	400	125	125	95	320	250	180	225	14	65	280	-	-	-	-	-	56

Wilo-Bloc-BM Ölçüler, Ağırlıklar

Ölçüler, Ağırlıklar (1450 d/d)

Wilo-Bloc-BM ...	Nominal Çap Ölçüler ve Ağırlıklar																
	f	a	m1	m2	n1	n2	h1	h2	s	b	w	x1	x2	z1	z2	d	Ağırlık [kg]
	[mm]																
BM 80/195-4/4	427	125	125	95	345	280	180	250	14	65	304	-	-	-	-	-	71
BM 80/210-5,5/4	490	125	125	95	345	280	180	250	14	65	352	-	-	-	-	-	86
BM 80/230-7,5/4	569	125	160	120	400	315	200	280	18	80	431	-	-	-	-	-	107
BM 80/270-9/4	569	125	160	120	400	315	200	280	18	80	431	-	-	-	-	-	111
BM 80/290-11/4	651	125	160	120	400	315	250	315	18	80	160	410	370	320	255	14	252
BM 80/315-15/4	651	125	160	120	400	315	250	315	18	80	160	410	370	320	255	14	273
BM 80/340-22/4	707	125	160	120	400	315	250	315	18	80	196	410	370	345	280	14	303
BM 100/185-5,5/4	505	125	160	120	360	280	200	280	18	80	146	320	280	260	215	12	124
BM 100/220-7,5/4	543	125	160	120	360	280	200	280	18	80	164	320	280	260	215	12	130
BM 100/250-9/4	656	140	160	120	400	315	225	280	18	80	190	410	370	320	255	14	174
BM 100/270-15/4	681	140	160	120	400	315	225	280	18	80	190	410	370	320	255	14	189
BM 100/295-18,5/4	754	140	160	120	400	315	250	315	18	80	226	410	370	345	280	14	323
BM 100/315-22/4	754	140	160	120	400	315	250	315	18	80	226	410	370	345	280	14	331
BM 100/340-30/4	754	140	160	120	400	315	250	315	18	80	186	410	305	390	318	18	366
BM 125/235-11/4	681	140	160	120	400	315	250	355	18	80	190	410	370	320	255	14	236
BM 125/270-18,5/4	754	140	160	120	400	315	250	355	18	80	226	410	370	345	280	14	276
BM 125/295-18,5/4	753	140	200	150	500	400	280	355	24	100	225	410	370	345	280	14	448
BM 125/315-30/4	753	140	200	150	500	400	280	355	24	100	185	410	305	390	318	18	483

Ölçüler, Ağırlıklar (2900 d/d)

Wilo-Bloc-BM ...	Nominal Çap Ölçüler ve Ağırlıklar																
	f	a	m1	m2	n1	n2	h1	h2	s	b	w	x1	x2	z1	z2	d	Ağırlık [kg]
	[mm]																
BM 32/125-0,75/2	335	80	100	70	190	140	112	140	14	50	242	-	-	-	-	-	27
BM 32/130-1,1/2	335	80	100	70	190	140	112	140	14	50	242	-	-	-	-	-	28
BM 32/140-1,5/2	335	80	100	70	190	140	112	140	14	50	242	-	-	-	-	-	29
BM 32/150-1,5/2	335	80	100	70	240	190	132	160	14	50	242	-	-	-	-	-	33
BM 32/160-2,2/2	345	80	100	70	240	190	132	160	14	50	245	-	-	-	-	-	34
BM 32/170-3/2	369	80	100	70	240	190	132	160	14	50	270	-	-	-	-	-	35
BM 32/155-3/2	403	80	100	70	240	190	132	160	14	50	280	-	-	-	-	-	49
BM 32/165-4/2	424	80	100	70	240	190	132	160	14	50	301	-	-	-	-	-	55
BM 32/175-5,5/2	424	80	100	70	240	190	132	160	14	50	301	-	-	-	-	-	65
BM 32/210-4/2	424	80	100	70	240	190	160	180	14	50	300	-	-	-	-	-	46
BM 32/190-4/2	424	80	100	70	240	190	160	180	14	50	300	-	-	-	-	-	47
BM 32/210-5,5/2	424	80	100	70	240	190	160	180	14	50	300	-	-	-	-	-	52
BM 32/215-7,5/2	424	80	100	70	240	190	160	180	14	50	300	-	-	-	-	-	59
BM 32/220-7,5/2	422	100	125	95	320	250	180	225	14	65	300	-	-	-	-	-	66
BM 32/230-9/2	526	100	125	95	320	250	180	225	14	65	385	-	-	-	-	-	81
BM 32/240-11/2	526	100	125	95	320	250	180	225	14	65	167	320	280	258	216	12	88
BM 32/250-13,5/2	564	100	125	95	320	250	180	225	14	65	185	320	280	258	216	12	94
BM 32/260-17/2	564	100	125	95	320	250	180	225	14	65	185	320	280	258	216	12	100
BM 40/125-1,5/2	335	80	100	70	210	160	112	140	14	50	242	-	-	-	-	-	31
BM 40/135-2,2/2	347	80	100	70	210	160	112	140	14	50	245	-	-	-	-	-	32

Isıtma, Soğutma, İklimlendirme, Endüstri

Monoblok Pompalar

Wilo-Bloc-BM Ölçüler, Ağırlıklar

Ölçüler, Ağırlıklar (2900 d/d)

Wilo-Bloc-BM ...	Nominal Çap Ölçüler ve Ağırlıklar																
	f	a	m1	m2	n1	n2	h1	h2	s	b	w	x1	x2	z1	z2	d	Ağırlık
	[mm]																[kg]
BM 40/145-3/2	371	80	100	70	210	160	112	140	14	50	270	-	-	-	-	-	35
BM 40/155-3/2	369	90	100	70	240	190	132	160	14	50	270	-	-	-	-	-	38
BM 40/155-4/2	383	90	100	70	240	190	132	160	14	50	261	-	-	-	-	-	41
BM 40/165-4/2	403	90	100	70	240	190	132	160	14	50	280	-	-	-	-	-	42
BM 40/165-5,5/2	410	90	100	70	240	190	132	160	14	50	285	-	-	-	-	-	50
BM 40/170-5,5/2	424	90	100	70	240	190	132	160	14	50	305	-	-	-	-	-	50
BM 40/175-7,5/2	424	90	100	70	240	190	132	160	14	50	305	-	-	-	-	-	54
BM 40/185-4/2	424	100	100	70	265	212	160	180	14	50	305	-	-	-	-	-	50
BM 40/190-5,5/2	424	100	100	70	265	212	160	180	14	50	305	-	-	-	-	-	54
BM 40/210-7,5/2	424	100	100	70	265	212	160	180	14	50	305	-	-	-	-	-	61
BM 40/195-7,5/2	424	100	100	70	265	212	160	180	14	50	305	-	-	-	-	-	60

Ölçüler, Ağırlıklar (2900 d/d)

Wilo-Bloc-BM ...	Nominal Çap Ölçüler ve Ağırlıklar																
	f	a	m1	m2	n1	n2	h1	h2	s	b	w	x1	x2	z1	z2	d	Ağırlık
	[mm]																[kg]
BM 40/215-11/2	485	100	100	70	265	212	160	180	14	50	345	-	-	-	-	-	78
BM 40/220-9/2	526	100	125	95	320	250	180	225	14	65	385	-	-	-	-	-	87
BM 40/230-11/2	526	100	125	95	320	250	180	225	14	65	167	320	280	258	216	12	91
BM 40/255-15/2	564	100	125	95	320	250	180	225	14	65	185	320	280	258	216	12	96
BM 40/225-12,5/2	526	100	125	95	320	250	180	225	14	65	167	320	280	258	216	12	92
BM 40/235-15/2	526	100	125	95	320	250	180	225	14	65	167	320	280	258	216	12	96
BM 40/240-17/2	564	100	125	95	320	250	180	225	14	65	185	320	280	258	216	12	98
BM 40/250-18,5/2	650	100	125	95	320	250	180	225	14	65	138	410	370	320	255	14	137
BM 40/260-22/2	650	100	125	95	320	250	180	225	14	65	138	410	370	320	255	14	141
BM 50/120-2,2/2	347	100	100	70	240	190	132	160	14	50	245	-	-	-	-	-	38
BM 50/130-3/2	371	100	100	70	240	190	132	160	14	50	270	-	-	-	-	-	39
BM 50/140-4/2	396	100	100	70	240	190	132	160	14	50	275	-	-	-	-	-	44
BM 50/160-5,5/2	424	100	100	70	265	212	160	180	14	50	305	-	-	-	-	-	53
BM 50/170-7,5/2	424	100	100	70	265	212	160	180	14	50	305	-	-	-	-	-	60
BM 50/150-5,5/2	424	100	100	70	265	212	160	180	14	50	305	-	-	-	-	-	53
BM 50/165-7,5/2	424	100	100	70	265	212	160	180	14	50	305	-	-	-	-	-	60
BM 50/175-9/2	485	100	100	70	265	212	160	180	14	50	345	-	-	-	-	-	71
BM 50/200-9/2	490	102	100	70	265	212	162	202	14	50	350	-	-	-	-	-	77
BM 50/210-11/2	490	102	100	70	265	212	162	202	14	50	131	320	280	260	215	12	82
BM 50/215-15/2	528	102	100	70	265	212	162	202	14	50	149	320	280	260	215	12	89
BM 50/195-15/2	528	102	100	70	265	212	162	202	14	50	149	320	280	260	215	12	89
BM 50/205-17/2	528	102	100	70	265	212	162	202	14	50	149	320	280	260	215	12	90
BM 50/220-22/2	650	102	100	70	265	212	162	202	14	50	150	410	370	320	255	14	136
BM 50/225-17/2	564	100	125	95	320	250	180	225	14	65	185	320	280	260	215	12	94
BM 50/235-18,5/2	650	100	125	95	320	250	180	225	14	65	150	320	280	260	215	12	136
BM 50/235-20/2	650	100	125	95	320	250	180	225	14	65	150	320	280	260	215	12	138
BM 50/250-22/2	650	100	125	95	320	250	180	225	14	65	150	320	280	260	215	12	140

Wilo-Bloc-BM Ölçüler, Ağırlıklar

Ölçüler, Ağırlıklar (2900 d/d)

Wilo-Bloc-BM ...	Nominal Çap Ölçüler ve Ağırlıklar																
	f	a	m1	m2	n1	n2	h1	h2	s	b	w	x1	x2	z1	z2	d	Ağırlık [kg]
	[mm]																
BM 50/250-25/2	650	100	125	95	320	250	180	225	14	65	150	320	280	260	215	12	142
BM 50/260-30/2	675	100	125	95	320	250	180	225	14	65	140	410	370	320	255	14	249
BM 65/115-3/2	371	100	125	95	280	212	160	180	14	65	270	-	-	-	-	-	41
BM 65/125-4/2	393	100	125	95	280	212	160	180	14	65	275	-	-	-	-	-	46
BM 65/135-5,5/2	424	100	125	95	280	212	160	180	14	65	305	-	-	-	-	-	52
BM 65/145-7,5/2	424	100	125	95	280	212	160	180	14	65	305	-	-	-	-	-	58
BM 65/150-9/2	490	100	125	95	280	212	160	200	14	65	345	-	-	-	-	-	75
BM 65/160-11/2	490	100	125	95	280	212	160	200	14	65	131	320	280	260	215	12	81
BM 65/170-15/2	528	100	125	95	280	212	160	200	14	65	149	320	280	260	215	12	85
BM 65/180-15/2	528	100	125	95	320	250	180	225	14	65	149	320	280	260	215	12	93
BM 65/190-18,5/2	641	100	125	95	320	250	180	225	14	65	150	410	370	320	255	14	135
BM 65/200-22/2	641	100	125	95	320	250	180	225	14	65	150	410	370	320	255	14	141
BM 65/185-18,5/2	645	100	125	95	320	250	180	225	14	65	150	410	370	320	255	14	135
BM 65/195-22/2	650	100	125	95	320	250	180	225	14	65	150	410	370	320	255	14	141
BM 65/215-30/2	682	100	125	95	320	250	180	225	14	65	155	410	370	320	255	14	170
BM 65/220-22/2	676	100	160	120	360	200	202	250	18	80	192	320	254	309	264	12	245
BM 65/235-30/2	688	100	160	120	360	200	202	250	18	80	242	410	370	320	255	14	274
BM 65/250-37/2	688	100	160	120	360	280	202	252	18	80	256	355	305	395	315	18	285
BM 80/130-5,5/2	429	120	125	95	320	250	180	225	14	65	305	-	-	-	-	-	70
BM 80/140-7,5/2	429	120	125	95	320	250	180	225	14	65	305	-	-	-	-	-	83
BM 80/150-11/2	490	120	125	95	320	250	180	225	14	65	350	-	-	-	-	-	88
BM 80/160-15/2	490	120	125	95	320	250	180	225	14	65	131	320	280	260	215	12	93
BM 80/170-18,5/2	528	120	125	95	320	250	180	225	14	65	148	320	280	260	215	12	137
BM 80/180-22/2	650	120	125	95	320	250	180	225	14	65	149	410	370	320	255	14	139
BM 80/200-30/2	650	120	125	95	320	250	180	225	14	65	149	410	370	320	255	14	272
BM 80/210-37/2	760	120	125	95	345	280	180	250	14	65	235	410	370	320	255	14	280

Flanş Ölçüleri (emme tarafı)

Wilo-Bloc-BM ...	Nominal Flanş Çapı	Pompa Flanş Ölçüleri			
	DNA	D	K	C	[delik adeti x mm]
32	50	165	125	102	4 x 19
40	65	185	145	122	4 x 19
50	65	185	145	122	4 x 19
65	80	200	160	138	4 x 19
80	100	220	180	158	8 x 19
100	125	250	210	188	8 x 19
125	150	285	240	212	8 x 22

EN 1902-2'ye göre PN10 delikli

Isıtma, Soğutma, İklimlendirme, Endüstri

Monoblok Pompalar

Wilo-Bloc-BM Ölçüler, Ağırlıklar

Flanş Ölçüleri (basma tarafı)

Wilo-Bloc-BM ...	Nominal Flanş Çapı	Pompa Flanş Ölçüleri			
	DNM	D	K	C	[delik adeti x mm]
32	32	140	100	78	4 x 19
40	40	150	110	88	4 x 19
50	50	165	125	102	4 x 19
65	65	185	145	122	4 x 19
80	80	200	160	138	4 x 19
100	100	220	180	158	8 x 19
125	125	250	210	188	8 x 19

EN 1902-2'ye göre PN10 delikli